

Bir şeklin veya nesnenin etrafına **çevre** denir.

Aşağıdaki şekillerin çevrelerinin kaç birim olduğunu hesaplayınız. İki nokta arası 1 birimdir.

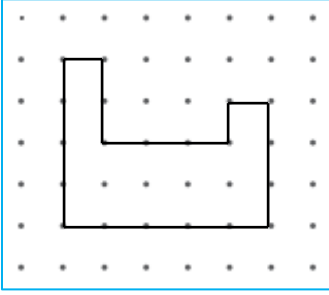

..... birim

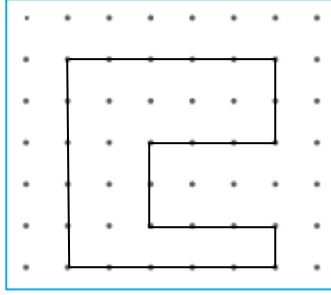

..... birim

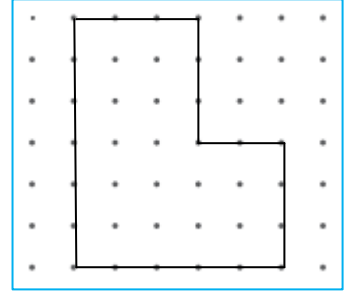

..... birim

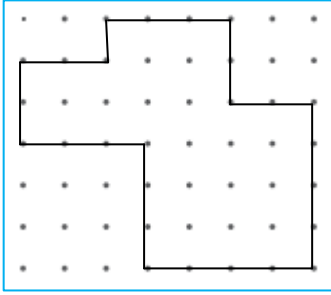

..... birim

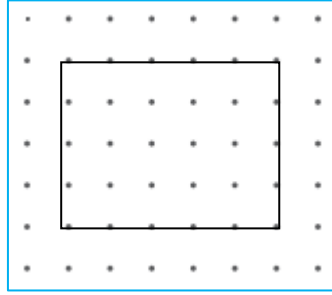

..... birim

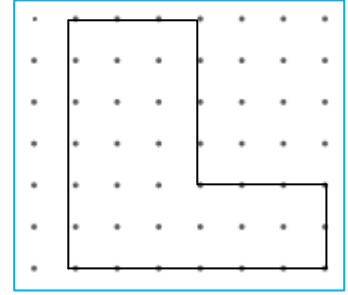

..... birim

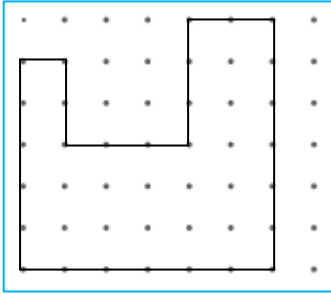

..... birim

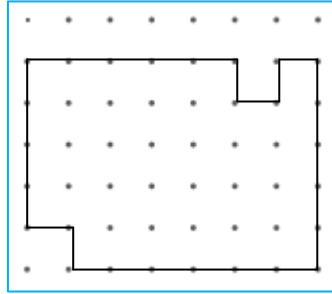

..... birim

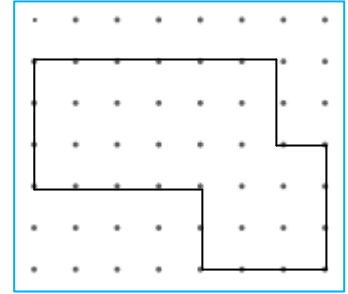

..... birim

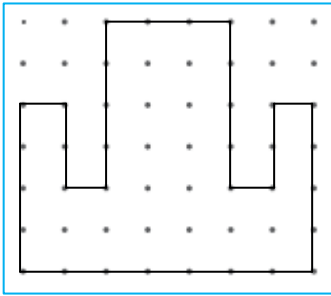

..... birim

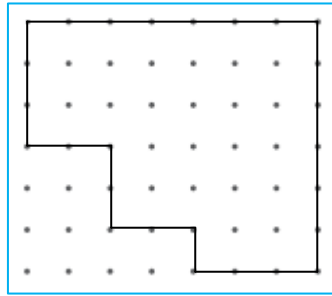

..... birim

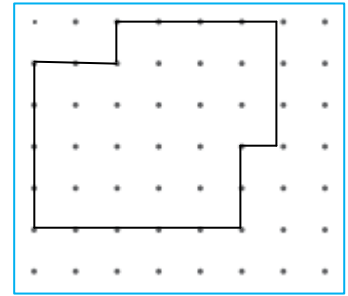

..... birim

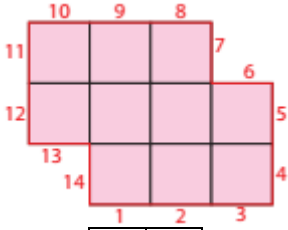

Bu tip sorularda her bir birim değeri kaç ise kenarlar o kadar ritmik sayılır.

Aşağıdaki şekillerin kaç birim olduğunu bulunuz.

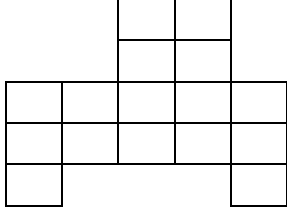

.....birim

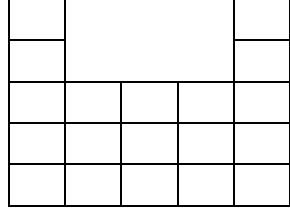

.....birim

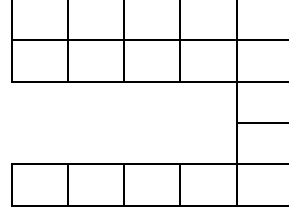

.....birim

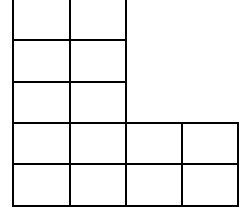

.....birim

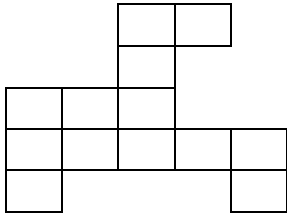

.....birim

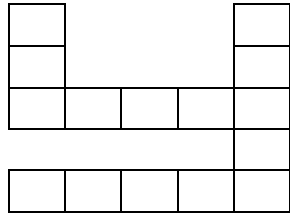

.....birim

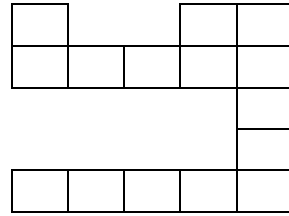

.....birim

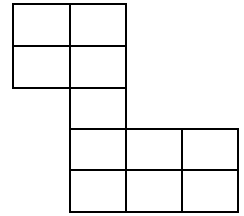

.....birim

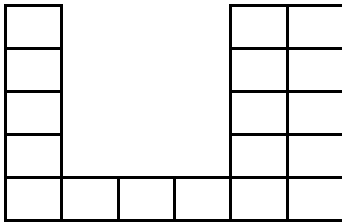

.....birim

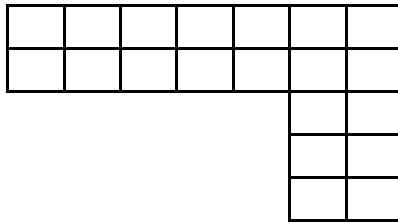

.....birim

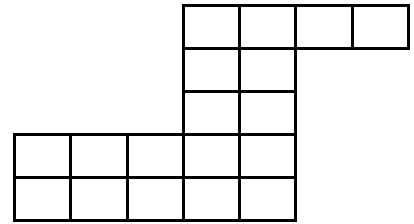

.....birim

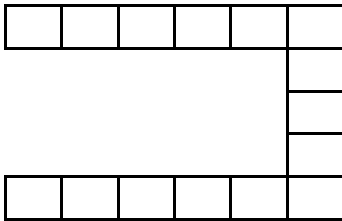

.....birim

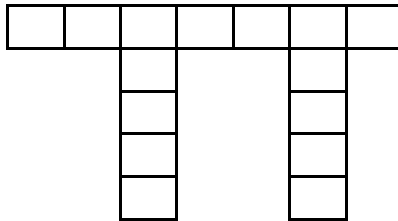

.....birim

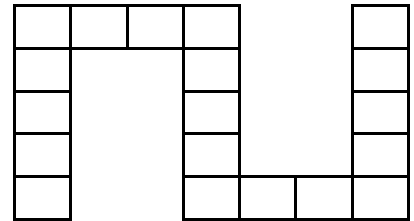

.....birim

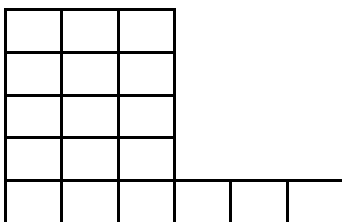

.....birim

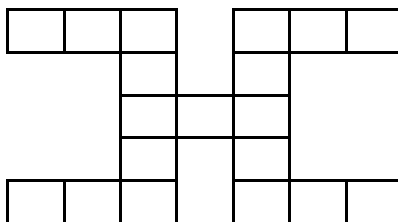

.....birim

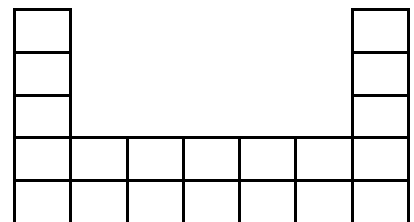

.....birim

Aşağıdaki şekillerin çevre uzunluklarını hesaplayınız.

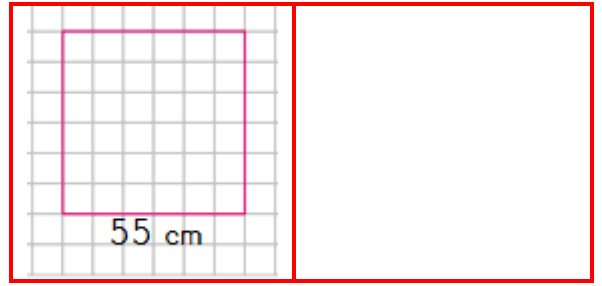
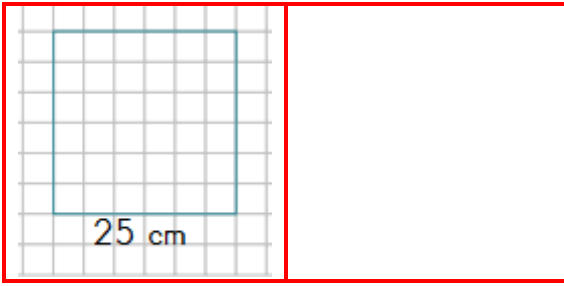
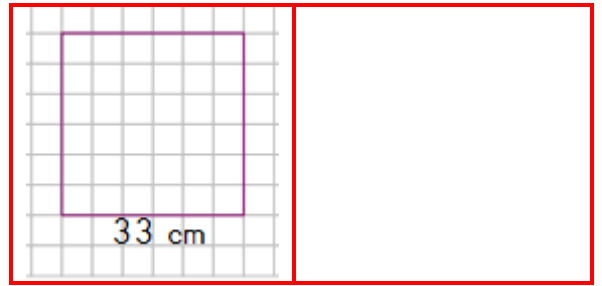
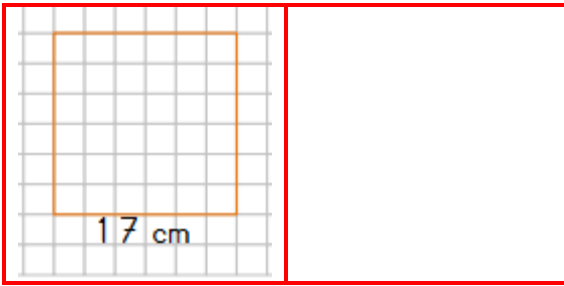
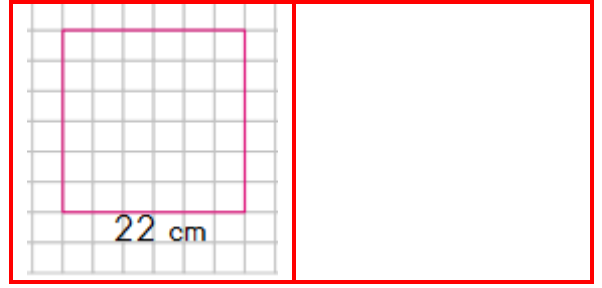
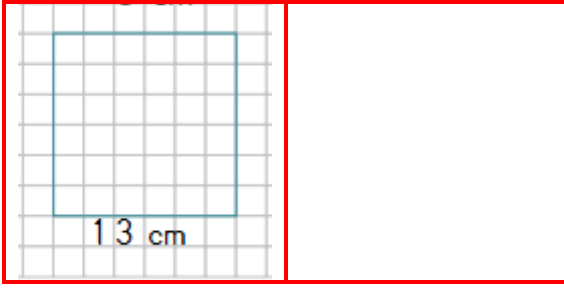
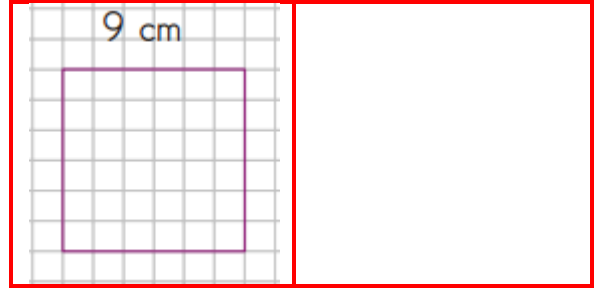
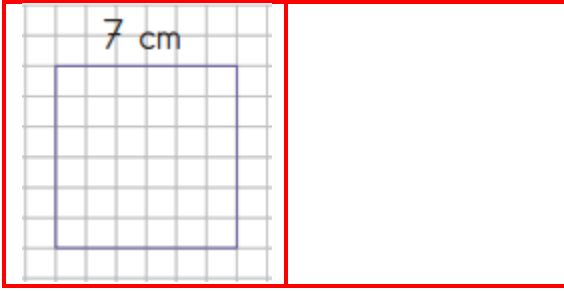
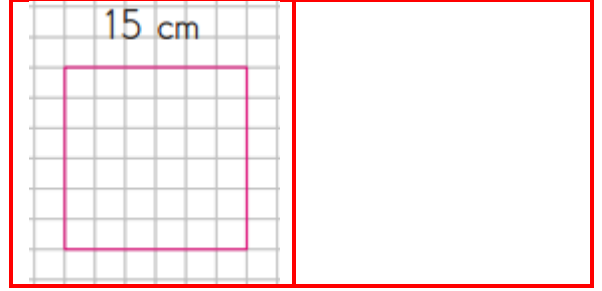
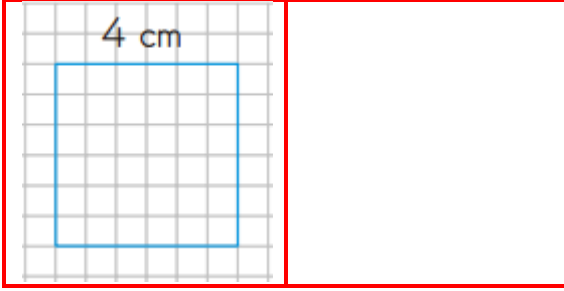

254

Aşağıdaki şekillerin çevre uzunluklarını hesaplayınız.

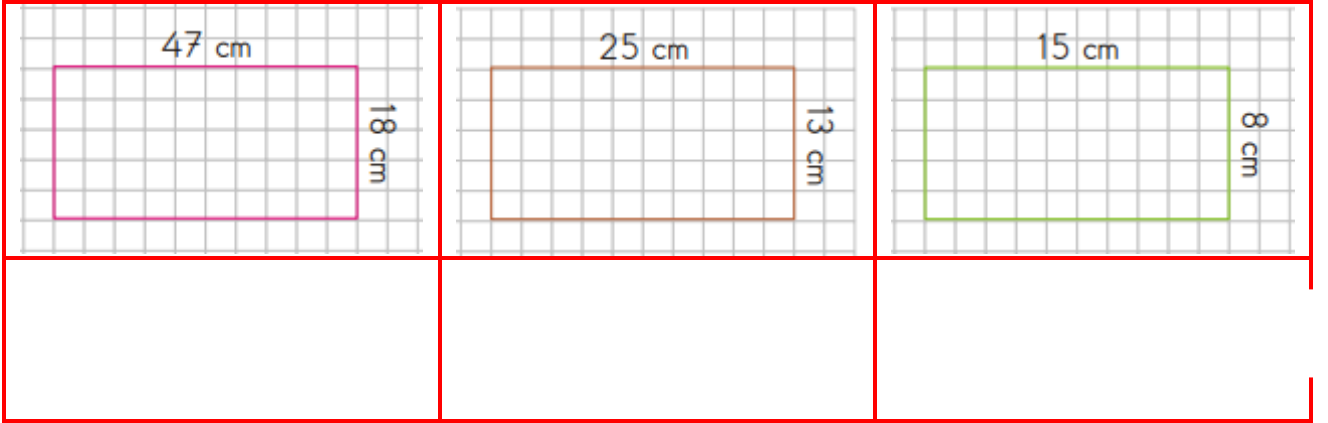
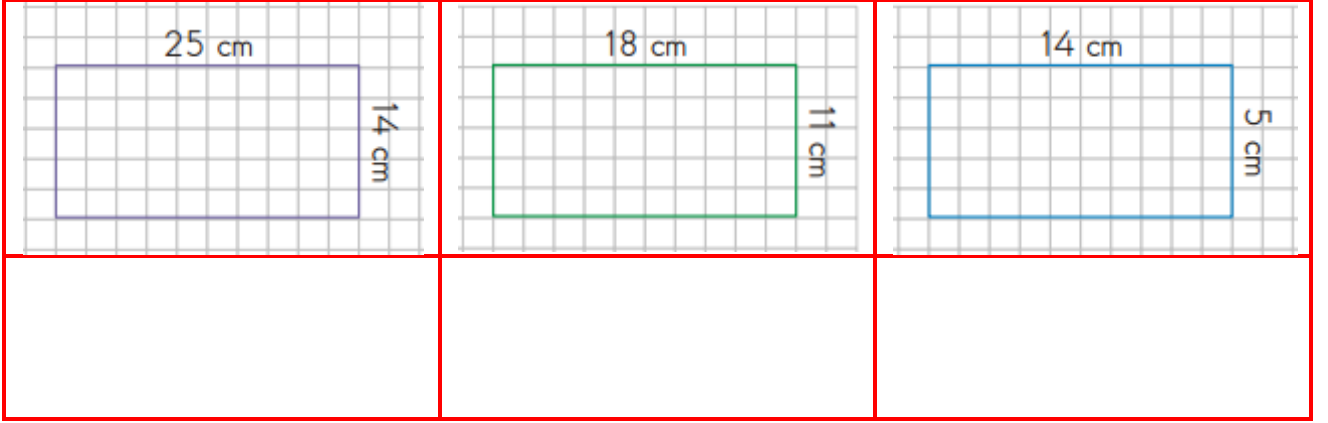



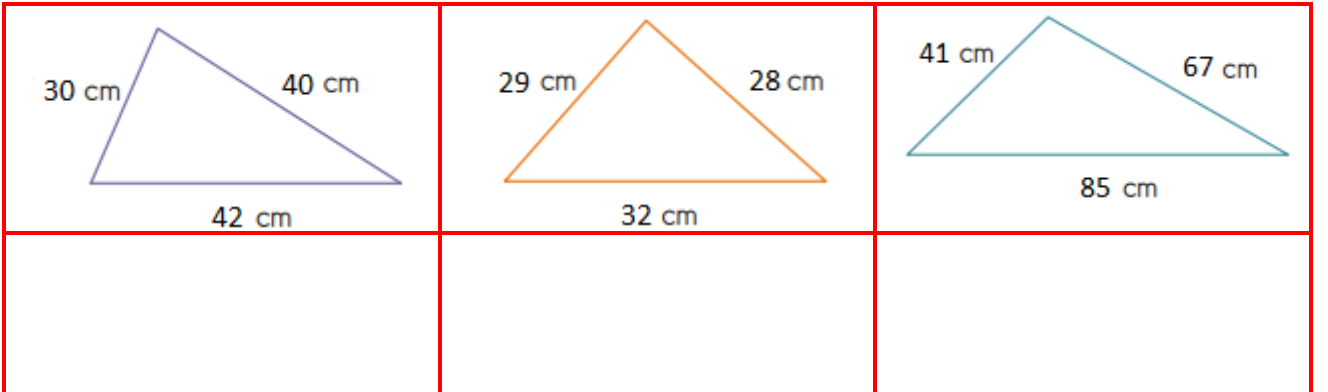
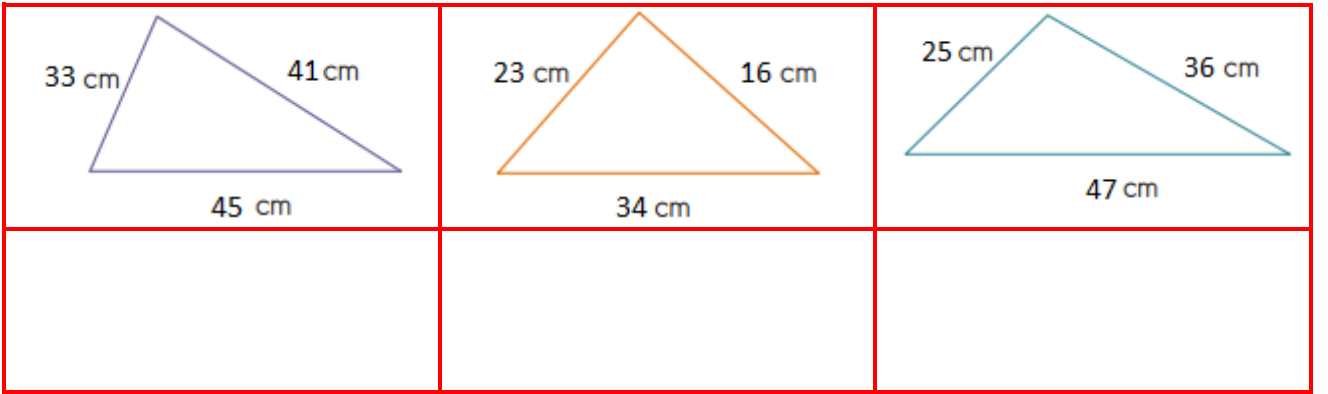

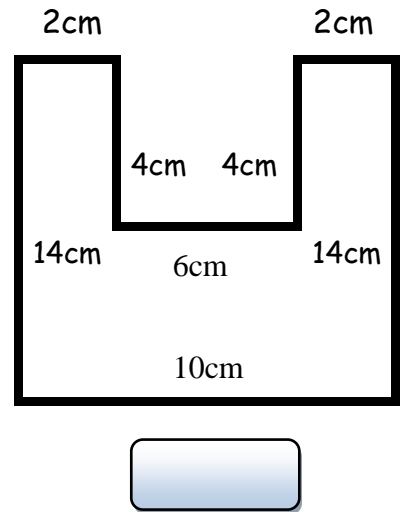
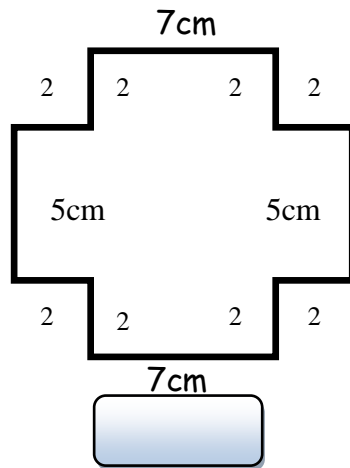
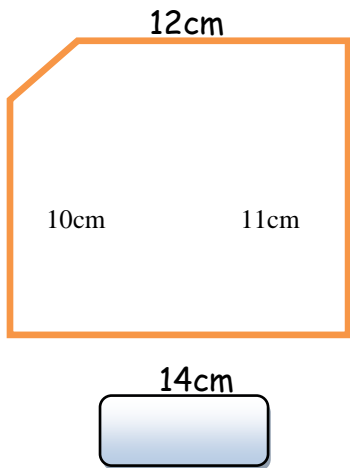
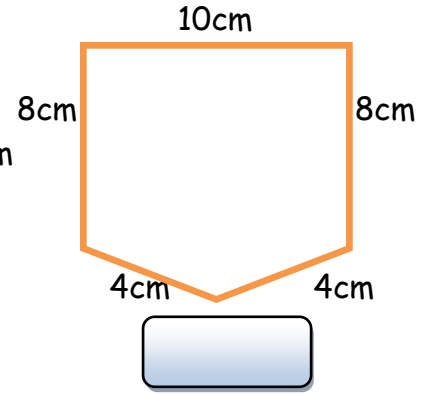
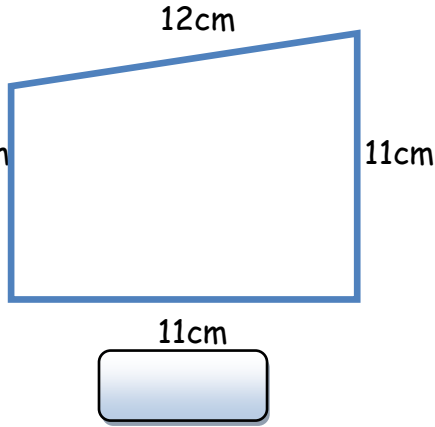
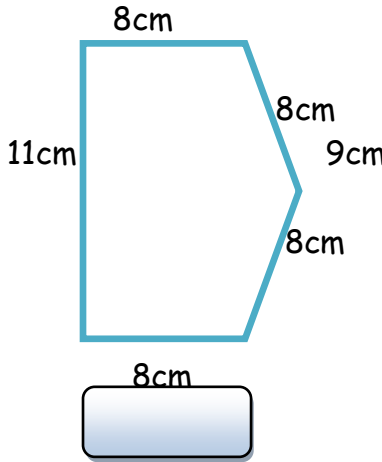
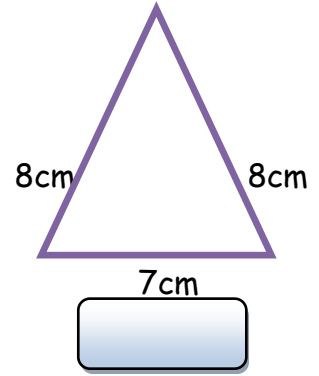
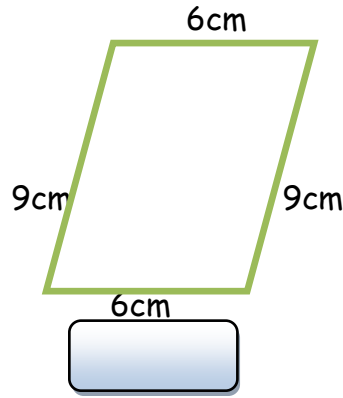
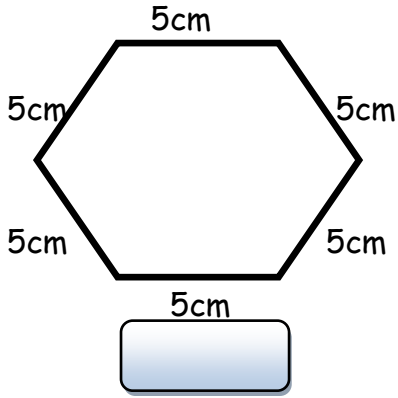
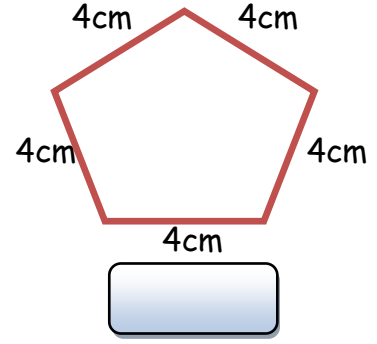
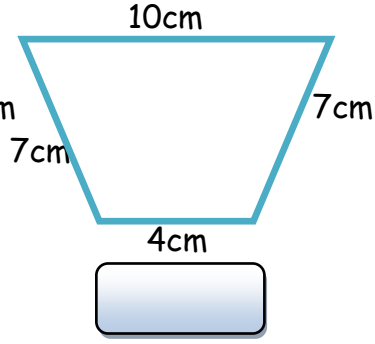
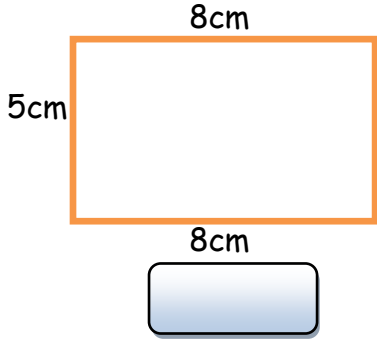

255

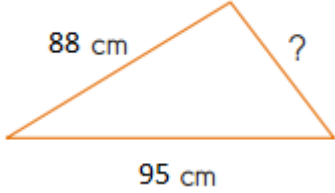
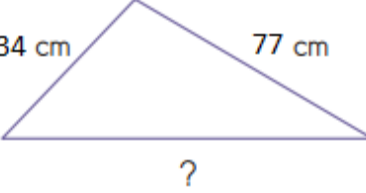
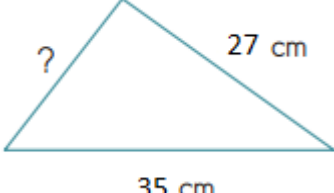
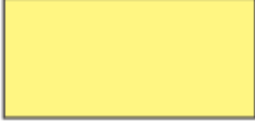

Aşağıdaki şekillerin çevresini hesaplayıp altına yazınız.

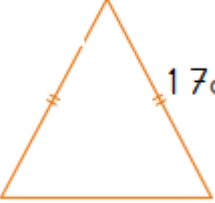
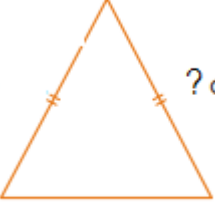
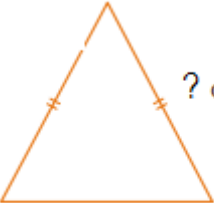

Aşağıdaki şekillerin kenar uzunluklarını bulunuz.

 <p>88 cm    ? 95 cm Ç = 250 cm</p>	 <p>34 cm    77 cm ? Ç = 175 cm</p>	 <p>?    27 cm 35 cm Ç = 250 cm</p>
 <p>14 cm ? cm Ç = 44 cm</p>	 <p>? cm 12 cm Ç = 56 cm</p>	 <p>? cm 23 cm Ç = 106 cm</p>
 <p>? cm Ç = 48 cm</p>	 <p>? cm Ç = 60 cm</p>	 <p>? cm Ç = 36 cm</p>
 <p>17 cm ? Ç = 47 cm</p>	 <p>? cm 22 cm Ç = 72 cm</p>	 <p>? cm 14 cm Ç = 54 cm</p>

Aşağıda bir evin küçük bir bölümü verilmiştir. Soruları bu krokiyi kullanarak cevapla.

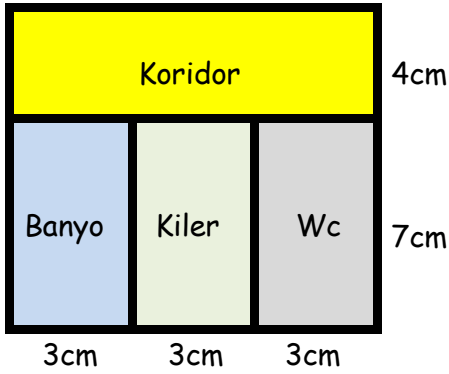

Karşılıklı kenarlar birbirine eşittir. Buna göre;

1) Banyonun çevresi kaç cm dir?.....

2) Koridorun çevresi kaç cm dir?.....

3) Kilerin çevresi kaç cm dir?.....

4) Wc nin çevresi kaç cm dir?.....

Aşağıdaki şekillerin çevrelerini hesaplayıp altına yazınız.

258

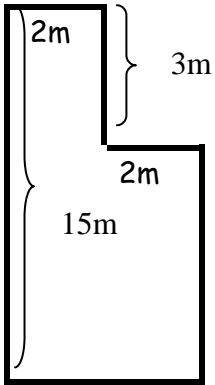

.....m

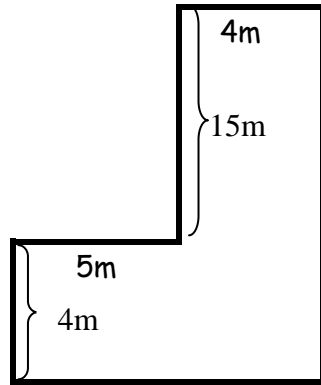

.....m

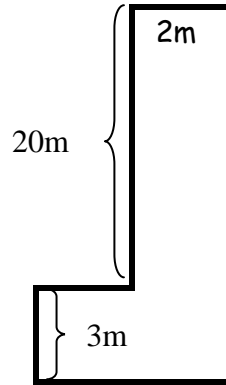

.....m

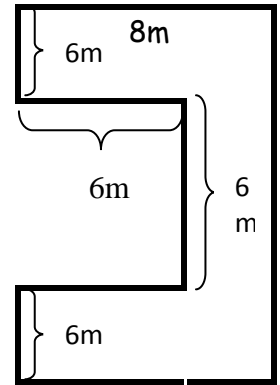

.....m

Kare



6m

.....m

Dikdörtgen

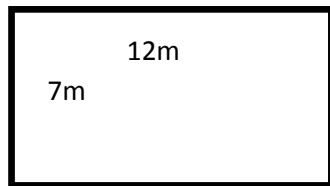

.....m

Eşkenar Üçgen

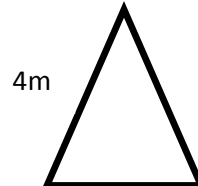

4m

.....m

Eşkenar Beşgen

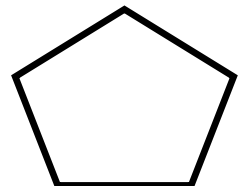

5m

.....m

Aşağıdaki çevre problemlerini çözünüz.

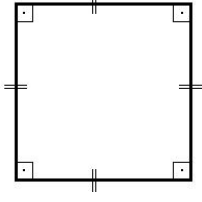

Bir kenarı 37 m olan kare şeklindeki seranın çevre uzunluğunu hesaplayınız.

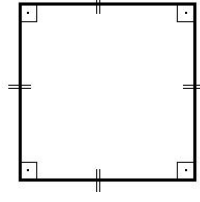

Çevresi 420 m olan kare şeklindeki bahçenin bir kenar uzunluğu kaç m'dir?

Uzun kenarı 124 cm, kısa kenarı 53 cm olan dikdörtgenin çevre uzunluğunu hesaplayınız.

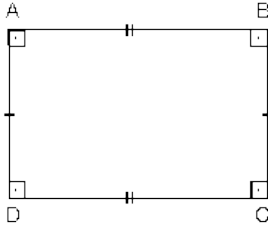

Dikdörtgen şeklindeki bayrağın bir uzun kenarı 148 cm ve çevresi 466 cm olduğuna göre, bir kısa kenarının uzunluğu kaç cm'dir?

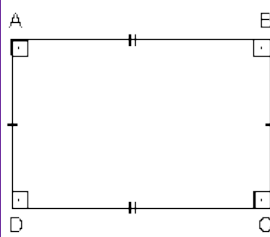

Bir kenarı 17 cm olan eşkenar üçgenin çevre uzunluğunu hesaplayınız.

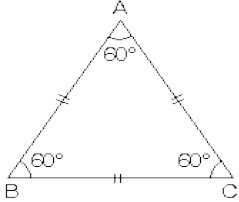

Çevresi 270 m olan eşkenar üçgen şeklindeki parkın bir kenar uzunluğu kaç m'dir?

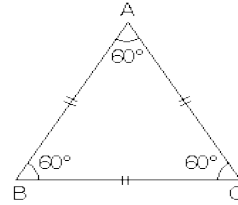

Kenar uzunlukları 17 cm, 28 cm ve 32 cm olan çeşitkenar üçgenin çevre uzunluğunu hesaplayınız.

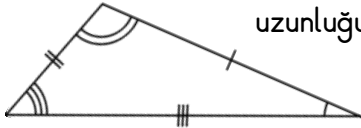

Çevresi 416 m olan ve kenarlarından biri 127 m, diğeri ise 185 m olan çeşitkenar üçgen şeklindeki tarlanın üçüncü kenarının uzunluğunu hesaplayınız.

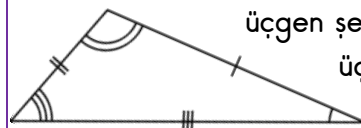



Aşağıdaki verilen şekillerin çevrelerini hesaplayınız.

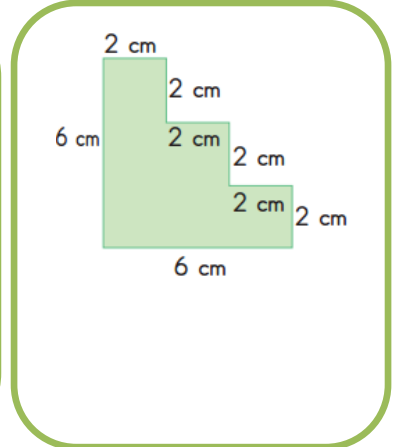
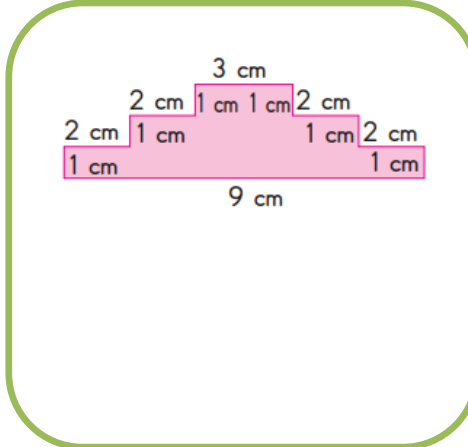
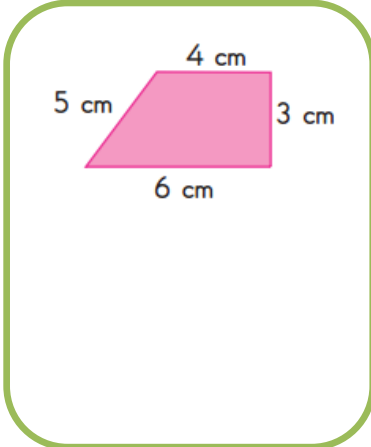
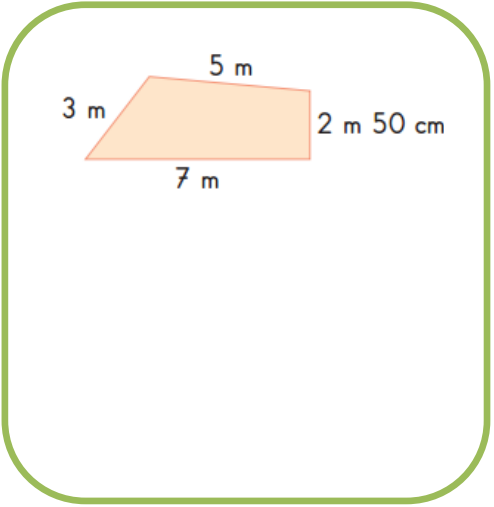
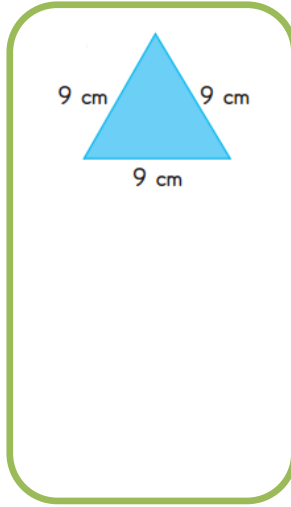
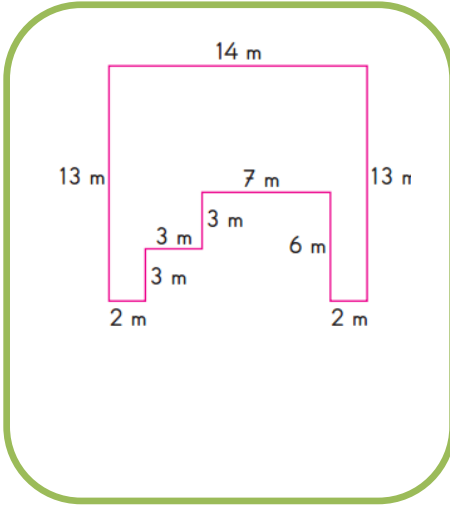
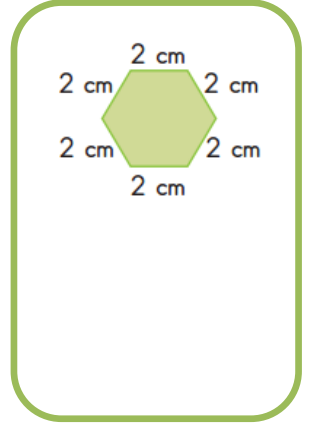
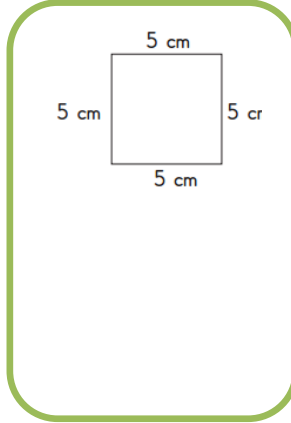
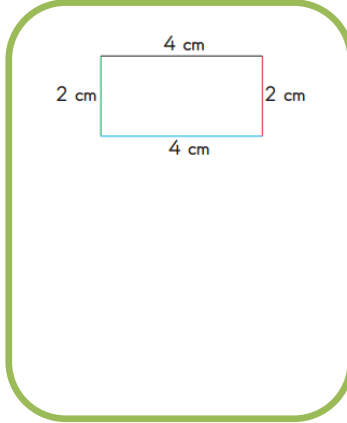
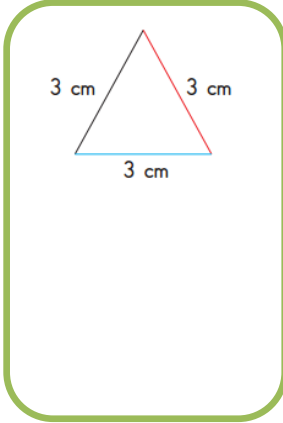

260

	<p>Yeşil Alan</p>	<p>Oyun Alanı</p>	<p>Çocuk Parkı</p>
--	-------------------	-------------------	--------------------